

料 号 705-VM0100-00

项 目 VM01 说明书

成品尺寸 75*105 mm

公 差 ±1mm

材 质 105g 哑粉纸

工 艺 骑马订

颜色要求 双色印刷

PANTONE 1235C

其 他

设计师 李佳龙 文案 吴水宁

重要: PDF 文件仅供预览, 实际印刷请使用 AI 转曲文档
(或 Cdr 转曲文档)

 刀模线 标示线刀模线
标示线 请勿印刷!

印刷要求:

色相正确、印迹牢固、套印准确、各色套印不露杂色,
套印误差≤1mm, 模切走位≤±1mm

合格证
QC PASS

ZENIKO

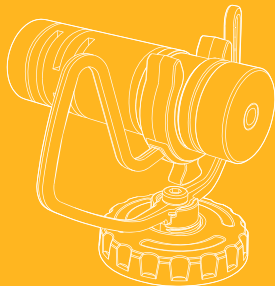

深圳卓立久科技有限公司

地址：广东省深圳市罗湖区桂园街道新围社区深南东路5033号金山大厦1208

电话：0755-25106331

Shenzhen Zeniko Technology Co., Ltd.

Add.: Room 1208, Jinshan Building, No. 5033 Shennan East Road, Xinwei Community,

Guiyuan Street, Luohu District, Shenzhen 518010, China

Tel: +86-755-25106331

www.zeniko.com

Made in China | 705-VM0100-00



VM01

轻型指向性枪式麦克风

Compact Directional Shotgun Microphone

前言

欢迎使用轻型指向性枪式麦克风 VM01, 本产品为主播、视频博主、记者等拍摄人群提供即插即用无需电池的便携式音频解决方案。常用于 Vlog、户外采访、直播以及短视频拍摄。请仔细阅读本说明书, 以便能正确的操作, 发挥本产品的优越性能。

产品特点

- 仅长 64mm, 仅重 37g;
- 即插即用, 无需额外供电;
- 机身全铝合金打造, 拥有更强的抗射频干扰能力;
- 配置专业减震支架及防风毛罩;
- 严格的灵敏度管控;
- 频率响应范围 50Hz-18KHz, 更好地收录清晰自然的声音;
- 高品质声学性能;
- 高信噪比同时具备极低的失真度。

警告

- ▲ 请勿私自拆卸产品, 如产品出现故障须由本公司或授权的维修人员进行检查维修。
- ▲ 请保持干燥: 请勿用湿手接触产品, 亦不可将产品浸入水中或暴露于雨中。
- ▲ 请勿让儿童接触本产品。
- ▲ 请勿在易燃易爆环境中使用。在这些场合下, 请注意相关警告标识。
- ▲ 请勿放置在超过 50 摄氏度的高温环境中。
- ▲ 使用供电的注意事项:
请勿给 VM01 幻象供电, VM01 需要插入式供电, 一般默认相机的 3.5mm 麦克风输入插口提供即可, 大约为 2-3V。连接相机或手机设备即可使用。
- ▲ 请仔细阅读并遵守由厂商提供的警告或指示。

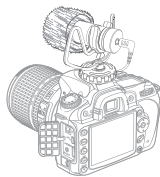

单反相机



智能手机

产品尺寸

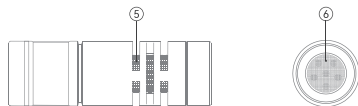
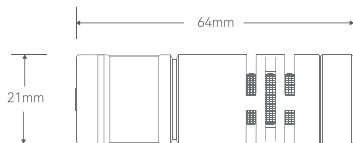

1. 防风毛罩
2. 麦克风机身
3. 3.5mm 音频接口

4. 减震支架
5. 侧面防护钢网
6. 咪头防护钢网

产品结构

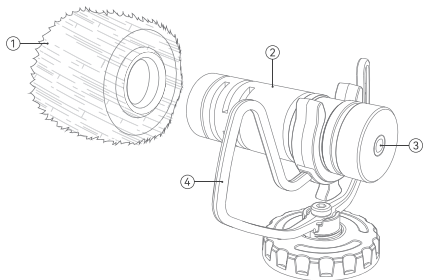

频率响应及指向性

— Frequency Response

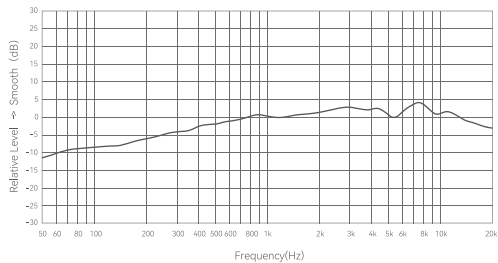

Polar Pattern

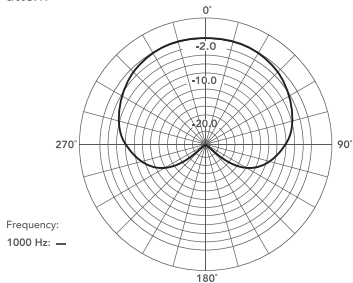

标配物品



麦克风×1



防风毛罩×1



减震支架×1

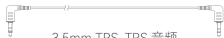

3.5mm TRS-TRS 音频
连接线 (相机适配线)×1



3.5mm TRS-TRRS 音频
连接线 (手机适配线)×1

温馨提示：说明书中的图片均为示意图，仅供参考。由于产品不断更新与升级，产品实物与图片可能存在差异，请以实物为准。

使用说明

一、安装防护罩、支架与音频线：

1. 将麦克风机身卡入减震支架上，同时确保麦克风处于中心位置，保持平衡与稳定。
2. 将所需防风毛罩套入麦克风机身的前端，毛罩内部具备容纳麦克风机身的形状，将麦克风机身插进到合适的位置即可。
3. 若需连接相机，请选择 3.5mm TRS-TRS 音频连接线并将其连接到麦克风身上的 3.5mm 接口。
4. 若需连接到手机使用，则 3.5mm TRS-TRRS 音频连接线，并将 3 极端子的一头连接线连接到麦克风接口，音频线的另一头即 4 极端子连接到手机上即可开始使用，**安卓 type-C 与苹果 lightning 需自备接头转接线。**

注：音频线插头需完全插入机身接口当中，避免出现不正常工作。

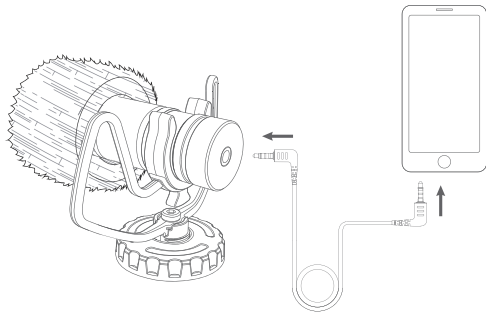

二、安装到相机:

1. 安装到相机之前, 将麦克风与冷靴座上的固定环逆时针转动, 使其松开到可以完全插入相机的冷靴当中。
2. 支架及麦克风安装到位后, 顺时针拧紧固定环。
3. 将 3.5mm TRS-TRS 音频连接线的一端连接到麦克风机身的接口上, 另一端连接到相机的麦克风输入插口。

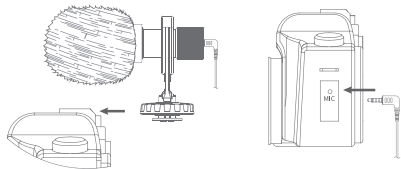

三、安装到支杆或话筒支架:

1. 将减震支架冷靴底座部的 3/8" (内配 1/4") 螺纹连接到您的支杆或者话筒支架所用的 3/8" 或 1/4" 螺纹;
2. 顺时针拧紧螺母, 注意不要过度拧紧。

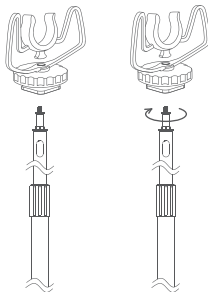

四、操作技巧:

为了本产品发挥更好的性能, 使用时请注意不要使用其他非官方配件, 如防风海绵, 防风毛罩。若使用其他厂商的音频线可能导致麦克风不能正常工作严重时可能损坏。避免手或其他物品遮挡住任何进音孔, 否则可能影响麦克风的性能。

VM01 不需要额外的电池供电就能工作, 但是需要通过相机麦克风的输入内置供电, 为了达到最佳的录音效果, 请参考如下设置您的相机音频输入:

音频输入: 麦克风输入

音频电平 / 增益控制: 手动(根据您的相机的熟练度与习惯)

插入式电源: 开启

另敬请参照您相机随附关于麦克风输入的说明, 了解调节音频设置更有助于您使用本产品。

规格参数

型号	VM01
信噪比	70dB
灵敏度	-38dB±2(0dB=1V/Pa at 1KHz)
音频频率范围	50Hz-18KHz
拾音模式	心型指向
最大声压级	120dB(THD≤3% at 1KHz)
等效噪声级 (A 计权)	20dB
音频连接线插头	3.5mm 接口
重量	37g
产品尺寸	长 64mm Φ21mm
工作温度	-10°C ~ +50°C

* 规格参数如有变更, 恕不另行通知。

维护保养

避免跌落：如果受到强烈碰撞或振动，设备可能会发生故障。

保持干燥：本产品是非防水产品，如果将其浸入水中或放置于高湿度的环境中将可能发生故障。内部构造生锈可能会导致无法修理的损害。

避免温度骤变：温度的突变，诸如在寒冷天进出温暖的大楼将可能会使产品内部结露。为避免结露，请将本产品事先装入手提袋或塑料包内，以防温度突变。

远离强磁场：无线电广播发射机等设备产生的强静电或强磁场可能会干扰本产品正常工作。

如有技术更改，恕不另行通知。

FORWARD

Thank you for purchasing Compact Directional Shotgun Microphone VM01. This product offers a portable audio recording solution for anchors, vloggers, journalists and more, featuring plug-and-play power input and rid of batteries. It can be commonly used for vlogging, outdoor interviews, live streaming, short videos shooting etc. Please read this manual carefully before using to make sure the correct operation and exert the optimum function.

PRODUCT FEATURES

- With 64mm's length and weighs 37g.
- Inserted into equipment to use directly without extra power supply.
- Aluminum alloy materials with stronger RFI resistance.
- With professional shock-absorbing bracket and furry windscreen.
- Strict sensitivity control.
- 50Hz-18KHz frequency response range to offer better voice recording and reproduce.
- High-quality voice performance.
- High signal noise ratio and low distortion degree.

WARNING

- ▲ Do not disassemble. Should repairs become necessary, this product must be sent to an authorized maintenance center.
- ▲ Always keep this product dry. Do not use in rain or in damp conditions.
- ▲ Keep out of reach of children.
- ▲ Please don't use it in flammable and combustible environments. In certain circumstance, please pay attention to the relevant warnings.
- ▲ Do not leave or store the product if the ambient temperature reads over 50°C.
- ▲ Observe precautions in power supply:
Do not supply VM01 with phantom power. As VM01 needs plug-in power supply, it is recommended to supply power by 3.5mm microphone input port of camera, which is about 2 to 3V. Connect the microphone to the camera or smartphone to use.
- ▲ Please carefully read and observe the warning or direction offered by the manufacturer.

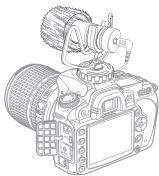

DSLR Camera



Smartphone

DIMENSION OF PRODUCT

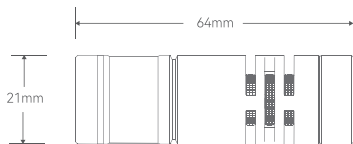

STRUCTURE OF PRODUCT

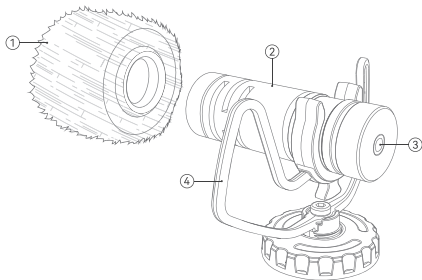

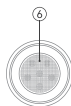

1. Furry Windscreen
2. Microphone Body
3. 3.5mm Audio Port
4. Shock-absorbing Bracket
5. Protective Steel Mesh
6. MIC Steel Mesh

FREQUENCY RESPONSE AND DIRECTIVITY

— Frequency Response

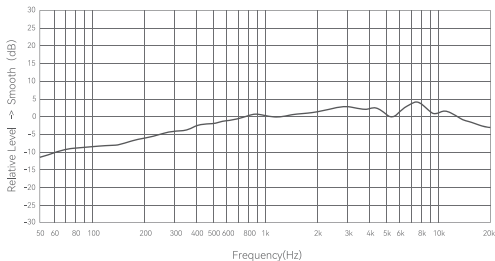

Polar Pattern

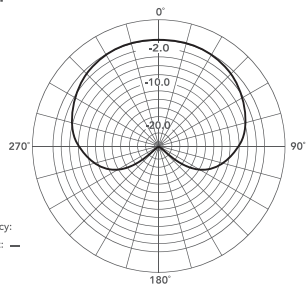

WHAT'S IN THE BOX



Microphone ×1



Furry Windscreen ×1



Shock-absorbing Bracket ×1



3.5mm TRS-TRS Audio Connect Cable (For Camera) ×1



3.5mm TRS-TRRS Audio Connect Cable (For Smartphone) ×1

Note: Due to continuous updates and upgrades of the products, there may be differences between the actual products and the pictures. Therefore, the pictures are for reference only, products to prevail in kind.

USAGE INSTRUCTION

Install Protective Cover, Bracket and Audio Cable

1. Insert the microphone into the shock-absorbing bracket and make sure that the microphone is placed in the center and keep balance.
2. Install the furry windscreen onto the former end of the microphone to the suitable place.
3. To connect to the camera, please choose the 3.5mm TRS-TRS Audio Connect Cable and insert it to the 3.5mm port of the microphone.
4. To connect to the smartphone, please choose the 3.5mm TRS-TRRS Audio Connect Cable and insert one end of the triple terminals into the microphone port. The other end of the audio cable, namely, the quadrupole terminal, shall be connected to the smartphone. Cables for Android Type-C and Apple lightning should be provided by oneself.

Note: the audio plug shall be fully inserted into the port to avoid abnormal working.

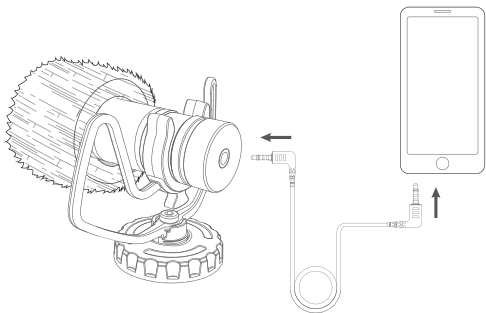

Attach to Camera

1. Before attaching to the camera, please turn the microphone's fixing ring counterclockwise to loosen it until the microphone can be fully inserted into the camera's coldshoe.
2. Lock the fixing ring by turning it clockwise after the bracket and microphone are installed.
3. Connect one end of 3.5mm TRS-TRS Audio Connect Cable to the microphone port and the other end to the camera's microphone input port.

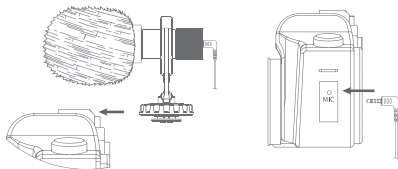

Attach to Microphone Stand

1. Connect the 3/8" (included 1/4" inside) mounting hole of shock-absorbing bracket to the 3/8" or 1/4" mounting hole of microphone stand.
2. Screw up the nut clockwise. Note: do not over tighten.

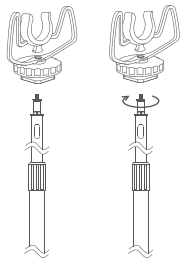

Operation Method

To exert the optimum function of this product, please do not use non-official included accessories e.g. windscreen foam or furry windscreen, etc. The microphone may do not work properly or be seriously damaged if using other manufacture's audio cables.

Do not block or shield any sound hole, otherwise, the microphone's performance may be influenced.

Although VM01 do not need extra battery to finish power supply, built-in power supply through camera's microphone is required. To achieve the best recording effects, please refer to the following operations to set your camera's audio input:

Audio input: through microphone

Audio level/gain control: manual (according to your proficiency and customs of camera)

Power insert: turn on

Please refer to the microphone input instructions of your camera to know more about the audio settings and adjustments, which will contributes a lot to use this product.

TECHNIQUE DATA

Model	VM01
Signal-noise ratio	70dB
Sensitivity	-38dB±2 (0dB=1V/Pa at 1KHz)
Audio frequency range	50Hz-18KHz
Pick-up sound mode	Cardioid directivity
Max. sound pressure level	120dB (THD≤3% at 1KHz)
Equivalent noise level (A-weighting)	20dB
Audio cable plug	3.5mm port
Weight	37g
Dimension	64mm Φ21mm
Working temperature	-10°C to +50°C

* Specifications and data may subject to changes without notice.

MAINTENANCE

Avoid sudden drops. The device may fail to work after strong shocks, impacts, or excess stress.

Keep dry.

The product isn't water-proof. Malfunction, rust, and corrosion may occur and go beyond repair if soaked in water or exposed to high humidity.

Avoid sudden temperature changes. Condensation happens if sudden temperature changes such as the circumstance when taking the product out of a building with higher temperature to outside in winter. Please put the product in a handbag or plastic bag beforehand.

Keep away from strong magnetic field. The strong static or magnetic field produced by devices such as radio transmitters leads to malfunction.

Changes made to the specifications or designs may not be reflected in this manual.

FCC STATEMENT

This device complies with part 15 of the FCC Rules. Operation is subject to the following two conditions:

- (1) This device may not cause harmful interference, and
- (2) this device must accept any interference received, including interference that may cause undesired operation.

Any Changes or modifications not expressly approved by the party responsible for compliance could void the user's authority to operate the equipment.

Note: This equipment has been tested and found to comply with the limits for a Class B digital device, pursuant to part 15 of the FCC Rules. These limits are designed to provide reasonable protection against harmful interference in a residential installation. This equipment generates uses and can radiate radio frequency energy and, if not installed and used in accordance with the instructions, may cause harmful interference to radio communications. However, there is no guarantee that interference will not occur in a particular installation. If this equipment does cause harmful interference to radio or television reception, which can be determined by turning the equipment off and on, the user is encouraged to try to correct the interference by one or more of the following measures:

- Reorient or relocate the receiving antenna.
- Increase the separation between the equipment and receiver.
- Connect the equipment into an outlet on a circuit different from that to which the receiver is connected.
- Consult the dealer or an experienced radio/TV technician for help.

DECLARATION OF CONFORMITY

GODOX Photo Equipment Co.,Ltd. hereby declares that this equipment are in compliance with the essential requirements and other relevant provisions of Directive 2014/30/EU. They are allowed to be used in all EU member states.

For more information of DoC, Please click this web link:

https://www.godox.com/DOC/Godox_VM01_DOC.pdf

产品保修

尊敬的用户，本保修卡是申请保修服务的重要凭证，请您配合销售商填写并妥善保管，谢谢！

产品信息	型号	产品条码
用户信息	姓名	联系电话
	通信地址	
销售商信息	名称	
	联系电话	
	通信地址	
	销售日期	
备注		

注：此表应由销售商盖章确认。

适用产品

本文件适用于相关《产品保修信息》(见后面说明)所列产品，其他非属此范围的产品或部件(如促销品、赠品及其他出厂后附加的部件等)不在此保修承诺内。

保修期

产品及部件的相应保修期按相关的《产品保修信息》执行。保修期自产品首次购买日起算，购买日以购买产品时保修卡登记日期为准。

如何获得保修服务

要保修服务，您可直接与产品销售商或授权服务机构联系，也可拨打卓立久产品服务电话，与我们联系，由我们的服务人员为您安排服务。申请保修时，您应提供有效的保修卡作为保修凭证，方可获得保修。如您不能提供有效的保修卡，则在我们可确认产品或部件属于保修范围的情况下，也可以为您提供保修，但这不作为我们的义务。

不适用保修的情况

如产品存在下列情况，本文件项下的保证和服务将不适用 ① 产品或部件超过相应保修期；② 错误或不当使用、维护或保管导致的故障或损坏，如：不当搬运；非按产品合理预期用途使用；不当插拔外接设备；跌落或外力挤压；接触或暴露于不当温度、溶剂、酸碱、水浸或潮湿环境；③ 由非卓立久授权机构或人员安装、修理、更改、添加或拆卸造成的故障或损坏；④ 产品或部件原有识别信息被修改变更或删除；⑤ 无有效保修卡；⑥ 使用非合法授权、非标准或非公开发行的软件造成的故障或损坏；⑦ 因不可抗力或意外事件造成的故障或损坏；⑧ 其他非因产品本身质量问题导致的故障或损坏。遇上述情况，您应向相关责任方寻求解决，卓立久对此不承担任何责任。因非在保修期或保修范围内的部件、附件或软件导致产品不能正常使用的，不是保修范围内的故障。产品使用过程中正常的脱色，磨损和消耗，不是保修范围内的故障。

产品保修和服务支持信息

产品的保修期和服务类型按以下《产品保修信息》执行：

产品类别	选件名称	保修期(月)	保修服务类型
部件	电路板	12	客户送修
	电池	3	客户送修
	充电器等带电性能的部件	12	客户送修
其他	如电池盒、防风棉、防风毛掌、锁紧装置、手提绳、扎带、魔术贴、领夹、便携袋、包装等	无	无保修

卓立久产品售后服务电话：0755-25106331

WARRANTY

Dear customers, as this warranty card is an important certificate to apply for our maintenance service, please fill in the following form in coordination with the seller and safe-keep it. Thank you!

Product Information	Model	Product Code Number
Customer Information	Name	Contact Number
	Address	
Seller Information	Name	
	Contact Number	
	Address	
	Date of Sale	
Note:		

Note: This form shall be sealed by the seller.

Applicable Products

The document applies to the products listed on the Product Maintenance Information (see below for further information). Other products or accessories (e.g. promotional items, giveaways and additional accessories attached, etc.) are not included in this warranty scope.

Warranty Period

The warranty period of products and accessories is implemented according to the relevant Product Maintenance Information. The warranty period is calculated from the day(purchase date) when the product is bought for the first time, And the purchase date is considered as the date registered on the warranty card when buying the product.

How to Get the Maintenance Service

If maintenance service is needed, you can directly contact the product distributor or authorized service institutions. You can also contact the Zeniko after-sale service call and we will offer you service. When applying for maintenance service, you should provide valid warranty card. If you cannot provide valid warranty card, we may offer you maintenance service once confirmed that the product or accessory is involved in the maintenance scope, but that shall not be considered as our obligation.

Inapplicable Cases

The guarantee and service offered by this document are not applicable in the following cases: ①. The product or accessory has expired its warranty period; ②. Breakage or damage caused by inappropriate usage, maintenance or preservation, such as improper packing, improper usage, improper plugging in/out external equipment, falling off or squeezing by external force, contacting or exposing to the improper temperature, solvent, acid, base, flooding and damp environments, etc; ③. Breakage or damage caused by non-authorized institution or staff in the process of installation, maintenance, alternation, addition and detachment; ④. The original identifying information of product or accessory is modified, alternated, or removed; ⑤. No valid warranty card; ⑥. Breakage or damage caused by using illegally authorized, nonstandard or non-public released software; ⑦. Breakage or damage caused by force majeure or accident; ⑧. Breakage or damage that could not be attributed to the product itself. Once met these situations above, you should seek solutions from the related responsible parties and Zeniko assumes no responsibility. The damage caused by parts, accessories and software that beyond the warranty period or scope is not included in our maintenance scope. The normal discoloration, abrasion and consumption are not the breakage within the maintenance scope

MAINTENANCE AND SERVICE SUPPORT INFORMATION

The warranty period and service types of products are implemented according to the following

Product Maintenance Information:

Product Type	Name	Maintenance Period (month)	Warranty Service Type
Parts	Circuit Board	12	Customer sends the product to designated site
	Battery	3	
	Charger, Electrical Parts etc.	12	
Other Items	Battery Case, Windscreen Foam,Wind Cap, Locking Device,Lanyard, Tie, Velcro Tape,Clip, Bag, Package etc	NO	Without warranty

Zeniko After-sale Service Call: +86-755-25106331